

BS 13

Balise de sol 2W



Encastré de sol de balisage à Led

Matériaux : Colerette inox 316L ou aluminium peint couleur Corten RAL8028 - Corps peint noir

Montage : Pot d'encastrement en ABS - kit ressort fixation cloison creuse

Ø perçage pour montage sans pot d'encastrement : 40mm

Câblage : Encastré pré-câblé avec 2m HO5RN-F 2x0,75mm²

Type de leds : 1 Led de puissance OSRAM 2W

Optique : Balisage 1 ou 2 directions

Température / couleur : Blanc 4000K, 3000K, Bleu

Tension d'alimentation : 12VDC (Nécessite une alimentation vendue séparément) ou 230VAC

Consommation moyenne : 2,6W

Câblage : connexion de plusieurs encastrés en parallèle

Dim (Øxh) : 55x73mm (hors pot d'encastrement)

Poids : 0,25Kg

Température maximale à la surface du verre du luminaire : <50°C







Plage de température de fonctionnement : -20° à +40°C

Conformités : Certification CE - EN60598

EN 55015: 2006+ A1: 2007+A2: 2009

EN 61547 : 2009

EN 60529: 1991 + A1: 2000 (IP67)

					12V DC 	230V AC 
	Inox 316L Inox 316L Inox 316L	4000K 3000K Bleu	1 DIRECTION 1 DIRECTION 1 DIRECTION	115lm 105lm 38lm	BS133 WHD RI1 BS133 WHW RI1 BS133 B RI1	BS133 WHD RI1 C BS133 WHW RI1 C BS133 B RI1 C
	Inox 316L Inox 316L Inox 316L	4000K 3000K Bleu	2 DIRECTIONS 2 DIRECTIONS 2 DIRECTIONS	115lm 105lm 38lm	BS133 WHD RI2 BS133 WHW RI2 BS133 B RI2	BS133 WHD RI2 C BS133 WHW RI2 C BS133 B RI2 C
	Corten RAL 8028 Corten RAL 8028 Corten RAL 8028	4000K 3000K Bleu	1 DIRECTION 1 DIRECTION 1 DIRECTION	115lm 105lm 38lm	BS133 WHD RM1 BS133 WHW RM1 BS133 B RM1	BS133 WHD RM1 C BS133 WHW RM1 C BS133 B RM1 C
	Corten RAL 8028 Corten RAL 8028 Corten RAL 8028	4000K 3000K Bleu	2 DIRECTIONS 2 DIRECTIONS 2 DIRECTIONS	115lm 105lm 38lm	BS133 WHD RM2 BS133 WHW RM2 BS133 B RM2	BS133 WHD RM2 C BS133 WHW RM2 C BS133 B RM2 C

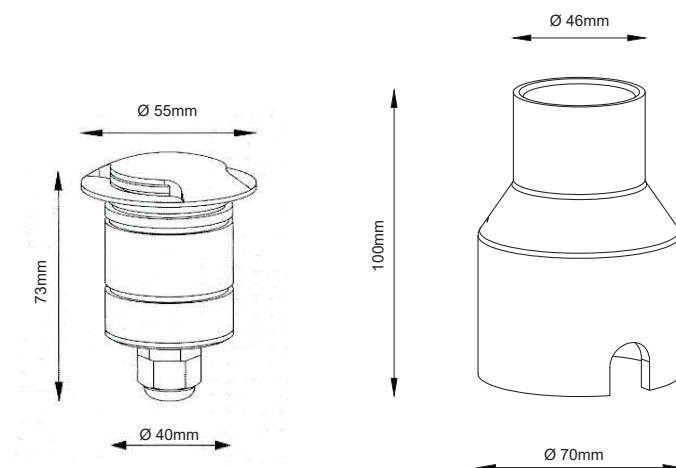

Alimentation et accessoires :

ALE12/10

12VDC 10W IP66

Pour toutes autres alimentations se reporter au chapitre ENERGIE



ESI13PE

Pot d'encastrement ABS supplémentaire



CE2/415

Connecteur étanche 1 entrée vers 1 sortie 4x1.5mm²



CE3/415

Connecteur étanche 1 entrée vers 2 sorties 4x1.5mm²

